



BLAST CHILLER / FREEZER

MANUAL OF INSTRUCTIONS FOR USE AND INSTALLATION



XB570L**BLAST CHILLER - QUICK CHILL AND HOLD FUNCTION****Contents**

1. General Features	1
2. Mounting & Installation	1
3. Electrical Connections	1
4. Connections	2
5. Frontal panel	2
6. QUICK START	2
7. How To Select A Cycle.	7
8. Parameters	7
9. How A Cycle Is Done.	11
10. Installation and mounting	13
11. XB07PR - Printer (optional)	14
12. Electrical connections	15
13. TTL Serial line	16
14. Use of the programming "HOT KEY "	16
15. ALARM SIGNALS	16
16. Technical data	17
17. Standard Value of the cycles.	17
18. Standard Values of the parameters.	19

1. General Features

The series XB has been created for fast chilling or freezing goods according to international food safety standards.

There are FOUR types of cycles:

- The CYCLES: Cy1, Cy2, Cy3, Cy4 are pre-set according to the most common cycles used in food - safety applications; the user can select one of them according to his own requirements and modify it as he wants.
- Any cycle can be manually terminated before the normal.
- Any cycle can use the insert probes (up to 3), they measure the internal temperature of the product.
- During the Cycle there are no defrosts and the fans are always on, a defrost cycle can be done before any freezing cycle.
- The cycle is divided up to 3 phases completely configurable by the user.
- Each instrument is provided with an output for remote display XR REP, which shows the temperature of cabinets or goods.
- The XB570L controller is provided with internal real time clock and can be connected to the XB07PR printer. This means that a report, which includes all the main features of cycle, can be printed: start and end of the cycle, length of the cycle, logging of the temperature of the cabinet and goods.

2. Mounting & Installation

Model XB570L is a controller panel mounted, hole dims 150x31 mm, and fixed with the screws. The ambient operating temperature range is 0÷60°C. Avoid locations subject to heavy vibration, corrosive gases or excessive dirt. The same applies to the probes. Ensure ventilation around the instrument.

3. Electrical Connections

The instruments are provided with a screw terminal block to connect cables with a cross section up to 2,5 mm² for probes and digital input.

Spade on 6,3mm heat-resistant wiring for supply and loads. Before connecting cables make sure the power supply complies with the instrument's requirements. Separate the input connection cables from the power

supply cables, from the outputs and the power connections. **Do not exceed the maximum current allowed on each relay**, in case of heavier loads use a suitable external relay.

3.1 PROBES CONNECTION

The probes shall be mounted with the bulb upwards to prevent damages due to casual liquid infiltration. It is recommended to place the thermostat probe away from air streams to correctly measure the average room temperature. Place the defrost termination probe among the evaporator fins in the coldest place, where most ice is formed, far from heaters and from the warmest place during defrost, to prevent premature defrost termination.

4. Connections

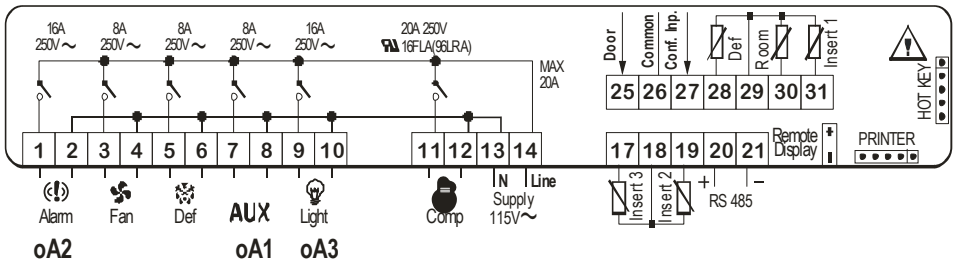

5. Frontal panel



6. QUICK START

6.1 DISPLAY

The upper display shows the temperature of the room probe.

The lower display shows the temperature of the inserts probe or the count down timer. To pass to the one insert probe to the another one use the DOWN key.

DISPLAY

- > Temperature.
- > Timer or insert probe
- > Alarm and status icons.

If an icon or LED is on, the correspondent function is enabled.

If an icon or LED is flashing, the correspondent function is delayed.

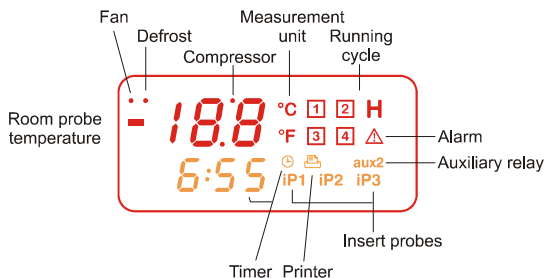

6.2 KEYBOARD IN STAND-BY

HOW TO SELECT A CYCLE:

Push and release the **P** (3) key till the desired cycle is selected.

HOW TO START A CYCLE: Push and release the START/STOP button (2). If the correspondent yellow LED is switched on..

HOW TO TEMPORARILY STOP THE RUNNING CYCLE.

1. Press and release the **STOP** key.
2. The compressor and the fan will be stopped for the PAU time (see parameters list) and the flashing message "Stb" will be displayed.
3. To restart the cycle press and release the **STOP** key, the cycle will restart from the some point at which it was interrupted.
4. In any case the cycle automatically restarts after the PAU time.

HOW TO STOP A CYCLE: hold pushed the START/STOP button (2) till the yellow LED will be switched off.

HOW TO SET THE TIME (RTC)

Hold pushed the **DOWN** key (5) till the Min label is displayed. Use the **UP** and **DOWN** KEY to browse the parameters.

TO MODIFY: push the **SET** button and then the UP and DOWN keys.

TO CONFIRM: push the **SET** button.

TO EXIT THE RTC MENU: Push together SET + UP keys or wait 5 sec.

1. HOW DISPLAY / MODIFY THE SET POINT OF THE HOLDING PHASE

TO DISPLAY: Push and release the **SET** key (6), the holding set point of the selected cycle is displayed for 5 sed..

TO MODIFY: while the set point is

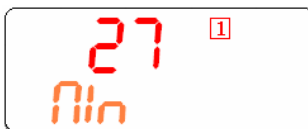
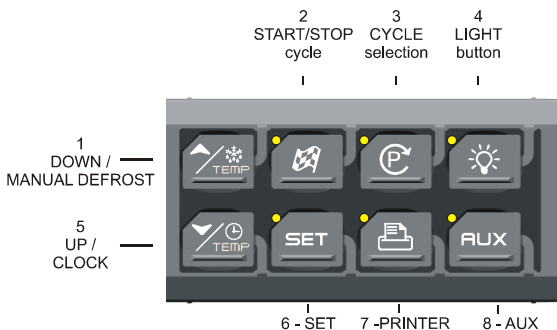

UP key: browse the menu:
 - Min= minutes
 - Hou= hours
 - daY= day
 - Mon= month
 - YEA= year
 - tiM= US/EUROPE time

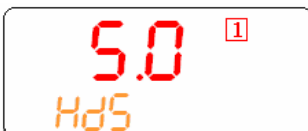

In this exemplum the holding set point of the cycle 1 is modified.

displayed hold pushed the SET key till the HdS label start flashing. Use the UP and DOWN key to modify the value..

TO CONFIRM: push the SET key to confirm the value and exit.

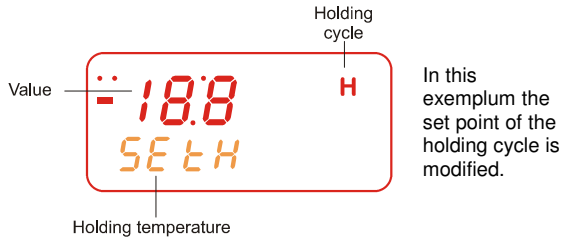

HOW MODIFY A CYCLE:

1. Push the **C** key (6) for several seconds till the first parameter (CyS) is displayed.
2. Use the UP and DOWN keys to browse the parameters.
3. To modify a parameter push the SET key and use the arrow keys.
4. Confirm the new value by pushing the SET key.
5. The new value is recorded even if the programming is exited by time out.

6.3 KEYBOARD WHEN A CYCLE 1,2,3,4 IS RUNNING

DISPLAY TEMPERATURES:

The **upper** display shows the temperature of the thermostat probe
 The **bottom** display shows the temperature of a insert probe (if enabled) or the count down timer.
 By pushing the **DOWN** key the probes iP1, iP2, iP3 and the count down timer are displayed in sequence.



PHASE DISPLAY: pushing the **UP** key the running phase is displayed.



PH1= phase 1
 PH2= phase 2
 PH3= phase 3

HOW TO DISPLAY THE REGULATION SET POINTS

By pushing the SET key the following information are displayed in sequence:
 - **rSI** = Room set point



- **iSI** = Stop phase set point, referred to the insert probe
- Back to the room temperature.

HOW TO MODIFY THE ROOM SET POINT

While rSi or iSi are displayed hold pushed the SET key till the rSi or iSi label start flashing and LED near the SET key is turned on..

Use the arrow key to modify the value and the SET key to confirm it.



6.4 KEYBOARD WHEN THE HOLDING CYCLE IS RUNNING (H)

HOW TO DISPLAY THE HOLDING (REGULATION) SET POINT

While the holding cycle is running, (H icon lighted), push the SET key and the holding set point is displayed on the UPPER display while the **SETH** label on the bottom display

HOW TO MODIFY THE ROOM SET POINT

While SETH is displayed hold pushed the SET key till the SETH label starts flashing and LED near the SET key is turned on..

Use the arrow key to modify the value and the SET key to confirm it.

TO CONFIRM AND EXIT: push again the SET key



6.5 OTHER KEYS

LIGHT (4): push the LIGHT (4) key to switch the light on and off. The status of the light is monitored by the yellow LED upper the key.

AUX (8): push the AUX (8) key to switch the auxiliary on and off. The status of the auxiliary relay is monitored by the yellow LED upper the key.

PRINTER / H (7): push the PRINTER key when the keyboard is connected to the controller, to enable/disable the printer.

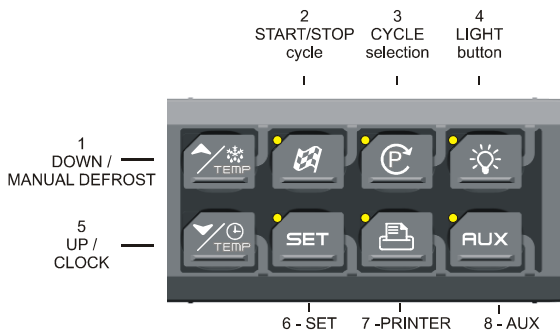

PRINTER CONFIGURATION MENU

Push the PRINTER (7) key for few seconds to enter the printer configuration menu.

The **itP**, label is displayed, use the ARROW kys to browse the parameters

To modify: push the **SET** key and then the ARROW keys.

To confirm: push the **SET** key

To exit the Printer menu: Push together SET + UP keys or wait 5 sec

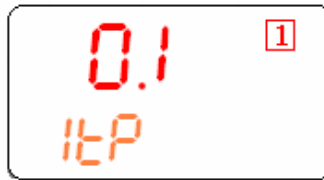

UP key: browse the menu:

- **itP**= time printing interval.
- **PbP**= data to print.
- **PAR**= enabled the printing of the parameter map.
- **Cyc**= enabled the printing of cycle parameters .
- **PTH**= enabled the printing during the holding phase.
- **PrS**= level Pr1 o Pr2.
- **Pnu**= number of printing.

DOWN key back to the previous label.







6.6 HOW TO START A MANUAL DEFROST.

Assure that none cycle is active or the hold mode is running.

1. Hold press the **UP** key fro few seconds.







NOTE: The defrost will not be done if the temperature detected by the evaporator probe is higher than EdF (stop defrost temperature) parameter.



6.7 OTHER FUNCTIONS OF KEYBOARD

	+		To lock & unlock the keyboard Pon/PoF
	+		To enter the programming mode when the controller is in stand-by Each parameter present in the Pr2 can be removed or put into "Pr1" (user level) by pressing "SET + ▼".
	+		To return to the previous menu.

6.8 MEANING OF THE LEDS'

A series of light points on the front panels is used to monitor the loads controlled by the instrument. Each LED function is described in the following table.

LED	MODE	ACTION
	ON	- Compressor enabled
	Flashing	- Programming Phase (flashing with LED ) - Anti-short cycle delay enabled
	ON	- Fans enabled
	Flashing	- Programming Phase (flashing with LED ) - Activation delay active
	ON	- Defrost active

LED	MODE	ACTION
	Flashing	- Drip time active
①②③④ H	ON	- Freezing cycle 1, 2, 3, 4 or hold mode active
①②③④ H	Flashing	- Instrument temporarily stop
	ON	- Alarm signalling
AUX – AUX2	ON	- Aux or Aux2 enabled

7. How To Select A Cycle.

1. Push the  to move among the cycles C1, C2, C3, C4 and the holding cycle. The related symbol on the display will be lighted and the cycle will be selected.



NOTE: to pass from a cycle to another one simply push the  key when the controller is in stand-by mode.

HOLD PHASE: To select **H** symbol pushing the .

Cycles are pre-set with the following values:

1. **Cy1:** for fast chilling and conservation of foods (hard +soft chill).
 2. **Cy2:** for chilling and fast freezing of foods (hard +soft + freezing cycle).
 3. **Cy3:** for direct fast freezing (only fast freezing cycle)
 4. **Cy4:** for fast freezing avoiding ice skin (hard chill + freezing cycle)
 5. **HLd:** hold mode function
 6. **dEF:** for starting a manual defrost
2. Now the cycle is memorised and can be activated.

7.1 HOW TO MODIFY A CYCLE

1. Verify that none cycle is running. If one cycle is running stop it by pushing the  key for 3s.
2. Push the  to move among the cycles C1, C2, C3, C4 and the holding cycle. The related symbol on the display will be lighted and the cycle will be selected
3. Hold push the  key for several seconds till the display will show the first parameter of the selected cycle (cyS) with its value.
4. Use the UP and DOWN keys to browse the parameters.
5. To modify a parameter push the SET key and use the arrow keys.
6. Confirm the new value by pushing the SET key.
7. The new value is recorded even if the programming is exited by time out.

TO exit: wait 30s or push the SET+UP keys.

8. Parameters

HyIntervention differential for set point: (0,1 ÷ 12,0 /0,1 °C/1 °F), always positive. Compressor cut IN is Set Point Plus Differential (Hy). Compressor cut OUT is when the temperature reaches the set point.

AC Anti-short cycle delay: (0÷30 min) minimum interval between the compressor stop and the following restart.

PAU Time of stand by: (0 ÷ 60min) after this time the controller restart the cycle

PfT Maximum acceptable duration of power failure: (0 ÷ 250 min) if power failure duration is less than PfT, the cycle restarts from the same point at which it was stopped otherwise the cycle restarts from the beginning of the current phase.

Con Compressor ON time with faulty probe: (0÷ 255 min) time during which the compressor is active in case of faulty thermostat probe. With CON=0 compressor is always OFF

COF Compressor OFF time with faulty probe: (0÷255 min) time during which the compressor is off in case of faulty thermostat probe. With COF=0 compressor is always active

PROBES

rPOThermostat probe calibration (-12,0 ÷ 12,0; res. 0,1 °C /1 °F)

EPP Evaporator probe presence (not present in the XB350C): (no / YES) **no:** not present (timed defrost); **YES:** present (end defrost)

EPO Evaporator probe calibration (not present in the XB350C): (-12,0 ÷ 12,0; res. 0,1 °C /1 °F)

i1P Insert probe 1 presence (no / YES) **no:** not present; **YES:** present.

i1o Insert probe 1 calibration (-12,0 ÷ 12,0; res. 0,1 °C /1 °F)

i2P Insert probe 2 presence (no / YES) **no:** not present; **YES:** present.

i2o Insert probe 2 calibration (-12,0 ÷ 12,0; res. 0,1 °C /1 °F)

i3P Insert probe 3 presence (no / YES) **no:** not present; **YES:** present.

i3o Insert probe 3 calibration (-12,0 ÷ 12,0; res. 0,1 °C /1 °F)

rEM End cycle probe selection. (iPt, rP). It sets which probe stops teh the cycle, thermostat probe or insert probe.

iPt = insert probe;

rPt =thermostat probe

NOTE, with rEM = rPt when the cycles are done by temperature, the rSi values are used as stop of the cycle.

DISPLAY AND MEASUREMENT UNIT

CF Temperature measurement unit: °C =Celsius; °F =Fahrenheit

rES Resolution (for °C): **in:** integer; **de:** with decimal point

Lod Upper display visualization: select which probe is shown by the upper display:

rP = Thermostat probe

EP = Evaporator probe

rEd Remote display, X-REP, visualization: select which probe is displayed by the X-REP:

rP = Thermostat probe; EP = Evaporator probe; **tiM:** cycle count down; **i1P** = insert probe 1; **i2P** = insert probe 2; **i3P** = insert probe 3.

DIGITAL INPUTS

d1P: Door switch input polarity (25-26): (OP÷CL)select if the digital input is activated by opening or closing the contact. **OP**= opening; **CL**=closing

odc Compressor and fan status when open door:

no = normal;

Fan = Fan OFF;

CPr = Compressor(s) OFF;

F_C = Compressor(s) and fan OFF.

doA Open door alarm delay:(0÷254min,nu) delay between the detection of the open door condition and its alarm signalling: the flashing message "dA" is displayed. If doA=nu the door alarm will be not signalled.

dLc Stop count down of the running cycle with door open **y** = count down is stopped with door open; **n** = count down goes on with door open;

rrd Regulation restart with door open alarm: **y** = count down and regulation restart when door open alarm is signalled.; **n** = compressor and fans stay according to the odc parameter when door open alarm is signalled.

d2F(EAL, bAL,) **Second digital input configuration (26-27):** **EAL:** external alarm; **bAL:** serious alarm, regulation is stopped.;

d2P: Configurable digital input polarity (26-27): (OP÷CL)select if the digital input is activated by opening or closing the contact. **OP**= opening; **CL**=closing

did Time delay for digital input alarm:(0÷255 min.) If d2F=EAL or bAL (external alarms), "did" parameter defines the time delay between the detection and the successive signalling of the alarm.

AUXILIARY RELAY CONFIGURATION

oA1 First auxiliary relay configuration (7-8):

ALL: alarm; **Lig:** light; **AuS:** Second thermostat; **tMr:** auxiliary relay enabled by keyboard
C2: Second compressor: it always is switched on during the Cycles, during the holding depends on the 2CH parameter

oA2 First auxiliary relay configuration (1-2):

ALL: alarm; **Lig:** light; **AuS:** Second thermostat; **tMr:** auxiliary relay enabled by keyboard
C2: Second compressor: it always is switched on during the Cycles, during the holding depends on the 2CH parameter

oA3 First auxiliary relay configuration (9-10)

ALL: alarm; **Lig:** light; **AuS:** Second thermostat; **tMr:** auxiliary relay enabled by keyboard
C2: Second compressor: it always is switched on during the Cycles, during the holding depends on the 2CH parameter

SECOND RELAY MANAGEMENT

2CH Compressors setting during the holding phase: (used only if one OAi =C2)

The second compressor is always switched on during the phases, during the holding depends on this parameter.

The 2CH sets which compressor is used during the holding phase.

Second compressor operates on set + OAS. (whit set= set loaded during the holding phase of each cycle). It starts oAt min. after the first compressor

The following table shows how it works:

	Holding
2CH =C1	C1 on;
2CH =C2	C2 on
2CH =1C2	C1 on; C2 On

OAt Second compressor switching on delay: (0÷255 min) time delay between the switching on of the first and second compressor.

OAS Set point for second compressor (-50÷50; ris.1 °C/ 1°F) This set point is a differential add to the set point of the first compressor.

ES. OAS=0 the set point of the second compressor s the same set point of the first compressor.

OAS=5 the set point of the second compressor is SET (of first compressor) + 5;

OAS=-5 the set point of the second compressor is SET (of first compressor) - 5;

OAH Differential for second compressor: (-12.0÷12,0; ris.0,1°C/1 °F, always ≠0) second compressor cut IN is SETH+OAS+OAH. Second compressor cut out is when the temperature SETH+OAS.

OAiProbe selection for the second compressor: **rP** = Thermostat probe; **EP** = Evaporator probe; **tiM:** cycle count down; **i1P** = insert probe 1; **i2P** = insert probe 2; **i3P** = insert probe 3.

AUXILIARY RELAY MANAGEMENT

OSt AUX output timer: (0÷255 min) time in which the AUX output stays ON. It is used when oA1 or oA2 or oA3 = tMr. With oAt = 0 the AUX relay is switched on and off only manually.

OSS Set point for AUX output, used when oA1 or oA2 or oA3 = AUS (-50÷50; ris.1 °C / 1°F)

OSH Differential for AUX output: (-12.0÷12,0; ris.0,1 °C/1 °F, always ≠0) Intervention differential for the set point of the AUX output, with OAH<0 the action is for heating, with OAH>0 it is for cooling.

COOLING, OSH >0: AUX output cut IN is OSS+OAH. Second compressor cut out is when the temperature SETH+OAS.

HEATING, OSH <0: second compressor cut IN is OSS-OAH. Second compressor cut out is when the temperature OSS

OSiProbe selection for the second compressor: **rP** = Thermostat probe; **EP** = Evaporator probe; **tiM:** cycle count down; **i1P** = insert probe 1; **i2P** = insert probe 2; **i3P** = insert probe 3.

DEFROST

tdF Defrost type (not present in the XB350C): (**rE**= electrical heater; **in** = hot gas).

IdF Interval between defrost cycles: (0.1÷ 24,0; res. 10 min) Determines the time interval between the beginning of two defrost cycles. (with 0.0 the defrost is disabled)

dtE Defrost termination temperature: (-50÷50 °C/°F) Sets the temperature measured by the evaporator probe, which terminates the defrost. Used only if EPP =YES

MdF Maximum length for defrost: (0÷255 min) When EPP = no (timed defrost) it sets the defrost duration, when EPP = YES (defrost termination based on temperature) it sets the maximum length for defrost.

dFd Temperature displayed during defrost: (rt , it, SEt, dEF) **rt:** real temperature; **it:** temperature at the start of defrost; **SEt:** set point; **dEF:** "dEF" message

Fdt Drip time: (0 ÷ 60 min) Time interval between reaching defrost termination temperature and the restoring of the controllers' normal operation. This time allows the evaporator to eliminate water drops that might have formed during defrost.

dAd Defrost display time out: (0÷120 min) Sets the maximum time between the end of defrost and the restarting of the real room temperature display.

FANS

FnC Fans operating mode during the holding phase:

o-n = continuous mode, OFF during defrost;

C1n= runs in parallel with the first compressor, OFF during defrost;

C2n= runs in parallel with the second compressor, OFF during defrost;

Cn= runs in parallel with compressors, OFF during defrost;

o-Y = continuous mode, on during defrost;

C1y= runs in parallel with the first compressor, on during defrost;

C2y= runs in parallel with the second compressor, on during defrost;

Cy= runs in parallel with compressors, on during defrost;

FSt Fan stop temperature: (-50÷50 °C/°F; res. 1 °C/1 °F). It is used only if the EPP = yES. If the temperature, detected by the evaporator probe is above FSt fans are stopped. It serves to avoid blowing warm air in the room.

AFH Differential for the stop temperature and for the alarm (0.1 ÷ 25.0 °C; ris.0.1°C/1 °F) Fans carry on working when the temperature reaches the FSt-AFH value, the temperature alarm recovers when the temperature is AFH degrees below the alarm set.

Fnd Fan delay after defrost: (0 ÷ 255 min) The time interval between end of defrost and evaporator fans start.

TEMPERATURE ALARMS

ALU MAXIMUM temperature alarm (it is used only during the holding phase): (1 ÷ 50 °C/°F) When the "SET+ALU" temperature is reached the alarm is enabled, (possibly after the "ALd" delay time).

ALL Minimum temperature alarm (it is used only during the holding phase): (1÷50°C/1 °F) When the "SET-ALL" temperature is reached the alarm is enabled, (possibly after the "ALd" delay time).

ALd Temperature alarm delay (it is used only during the holding phase): (0÷255 min) time interval between the detection of an alarm condition and alarm signalling.

EdA Temperature alarm delay at the end of defrost (it is used only during the holding phase): (0 ÷ 255 min) Time interval between the detection of the temperature alarm condition at the end of defrost and alarm signalling.

tbA Silencing alarm relay: (Yes= silencing buzzer and alarm relay, no= only buzzer silencing).

CYCLE LOG

tCy duration of the last cycle (readable only);

tP1 duration of first phase of the last cycle (readable only);

tP2 duration of second phase of the last cycle (readable only);

tP3 duration of third phase of the last cycle (readable only);

OTHER

Adr Address for RS485: (1 ÷247)

bUt Buzzer activation at the end of the cycle (0÷60s; with 0 the buzzer is on till a key is pushed)

tPb Kind of probe: it sets the kind of probe used:

ntc = NTC **o Ptc** = PTC.

rEL Release code (readable only)

Ptb Parameter code (readable only)

9. How A Cycle Is Done.

- Every programmable cycle Cy1, Cy2, Cy3 or Cy4 can be divided into up to 3 phases usually called:
 - **hard chill**
 - **soft chill**
 - **freezing cycle**
- For each phase there are 3 parameters.

iS1, (iS 2, iS 3): Set point related to the insert probes that stops the current phase.

rS1, (rS2, rS3): set point of the room temperature for each phase.

Pd1, (Pd2, Pd3): the maximum duration time for each phase.

Hds : set point of the hold phase at the end of the whole cycle.

There are also 3 parameters:

first one concerning the cycle way of doing the cycle: by temperature or by time, the other two are related to the defrost. These are **dbC** = defrost before cycle, **dbH** = defrost before holding (at the end of the cycle).

9.1 CONFIGURABLE CYCLE PARAMETERS

cyS Cycle setting: **tEP** = by temperature. the cycle is done according to the **rEM** parameter; **tiM**: timed cycle, based on the Pd1, Pd2, Pd3 parameters.

dbc(yes/no) Defrost before the cycle

iS1 (-50÷50°C; 1°C/1°F) **Insert Probe Set point**: when the temperature measured by the three insert probes reaches this value the first phase is ended.

rS1 (-50÷50°C; 1°C/1°F) **Room probe Set point** for the first phase: it prevents temperature from reaching a too low value during the hard cycle.

Pd1(OFF÷4.0h; 10 min) **Maximum time for first phase**

iS2 (-50÷50°C; 1°C/1°F) **Insert probe set point** when the temperature measured by the three insert probes reaches this value the second phase is ended.

rS2 (-50÷50°C; 1°C/1°F) **Room probe Set point** for the second phase: it prevents temperature from reaching a too low value during the second phase.

Pd2 OFF÷4.0h; res. 10 min **Maximum time for second phase.**

iS3 (-50÷50°C; 1°C/1°F) **Insert Probe Set point** to stop the third (and last) phase: when the temperature measured by the three insert probes reaches this value the third phase is ended.

rS3 (-50÷50°C; 1°C/1°F) **Room probe Set point** for the third (and last) phase: it prevents temperature from reaching a too low value during the third (and last) phase.

Pd3 (OFF÷4.0h; 10 min) **Maximum time for the third phase.**

dbH (yes / no) **defrost before the hold phase**

HdS (-50÷50 - OFF; 1 °C / 1 °F) **Set point of the holding phase.** With "OFF" the hold phase is disabled.

IMPORTANT NOTE: If the duration time of a phase is set at the OFF value, the corresponding phase is disabled. E.g. If **Pd3**= OFF the third phase of the cycle is not active.

9.2 HOW TO USE THE INSERT PROBES.

By means the insert probe, the internal temperature of products can be checked. This measure is used to end the various phase of the cycle. A special internal function detect if the inset probe is not used, in this case the cycle is made by time

9.3 EXAMPLE OF A BLAST CHILLER CYCLE.

The following drawing explains how a Blast Chiller cycle can be done.

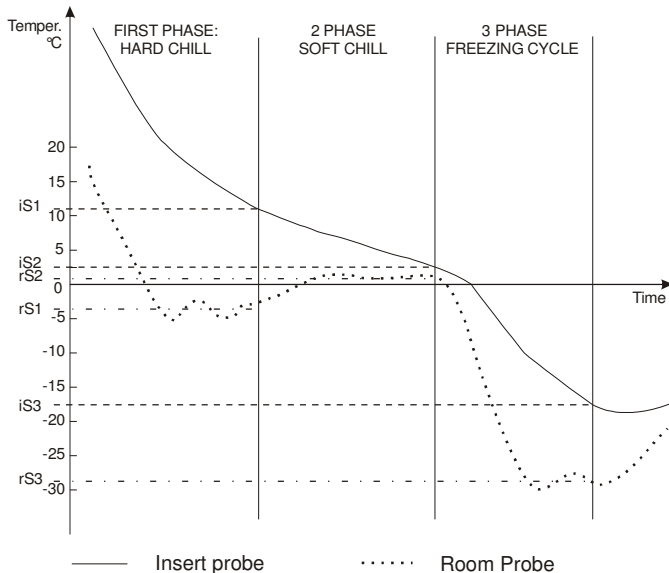

9.3.1 First phase: “Hard chill”.

It is normally used to fast chill hot foods. E.g. from 80°C / 170°F to 20°C / 70°F
 During “**Hard Chill**”, both compressor and fan are always on until the **rS1** temperature is reached. At this point compressor is turned on end off so as to keep the temperature of the room at the **rS1** value. “**Hard Chill**” ends when the temperature measured by the 3 insert probes reach the **iS1** value.

9.3.2 Second phase: “Soft chill”.

The **Soft Chill** starts when the Hard Chill ends. It is used to prevent thin layer of ice from forming on the product. The Soft Chill lasts until the temperature measured by the 3 insert probes reach the set point **iS2** (usually 4 or 5°C).
 During Soft Chill the temperature of the room is regulated by the ambient probe with the set point **rS2** (normally at 0 or 1 °C / 32 or 34°F). When the box temperature reaches the **rS2** value compressor is turned on end off so as to keep the temperature of the box at this value.

9.3.3 Third phase: “Freezing cycle”.

Freezing Cycle: used to fast freeze foods.
 The Freezing Cycle starts when the Soft Chill ends. During the “Freezing Cycle” both compressor and fan are always on until the **rS3** temperature is reached. At this point compressor and fans are turned on end off so as to keep the temperature of the room at the **rS3** value (normally some degrees below **iS3**). Freezing Cycle ends when the temperature measured by the 3 insert probes reach the **iS3** value (normally -18°C / 0°F), in any case it ends when the maximum time **Pd1 + Pd2 + Pd3** has expired.

9.3.4 End of the Blast Chill cycle and starting of the Hold Mode.

When one of the three insert probes reaches the **iS3** value the values End followed by the **i1P** or **i2P** or **i3P** are shown on the display.
 Cycle ends when all the probes have reached the **iS3** value. A signal is generated: buzzer and alarm relay is turned ON, the display shows the message “End” alternating with the room temperature.

The alarm automatically stops after the “**but**” time or by pressing any keys.
 At the end of the cycle the controller can start the “Hold mode” keeping the room temperature at the value set in **HdS** parameter.
 If **HdS** = OFF, the machine is turned OFF.

NOTE1: with **dbH = yES** a defrost is done before the holding phase.

NOTE2: If the end cycle temperature iS3 is not reached in the maximum time Pd1+Pd2+Pd3 the instrument keep on working, but the alarm message “OCF” is given.

10. Installation and mounting

Instruments **XB570L** shall be mounted on vertical panel, in a 150x31 mm hole, and fixed using two screws $\varnothing 3 \times 2$ mm. To obtain an IP65 protection grade use the front panel rubber gasket (mod. RG-L). The temperature range allowed for correct operation is 0 - 60 °C. Avoid places subject to strong vibrations, corrosive gases, excessive dirt or humidity. The same recommendations apply to probes. Let the air circulate by the cooling holes.

10.1 CUT OUT

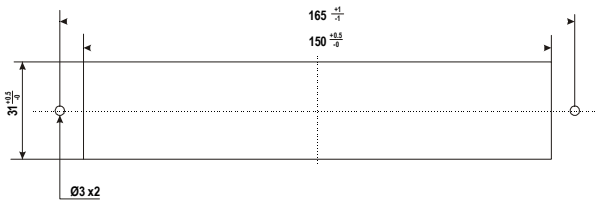

10.2 MOUNTING

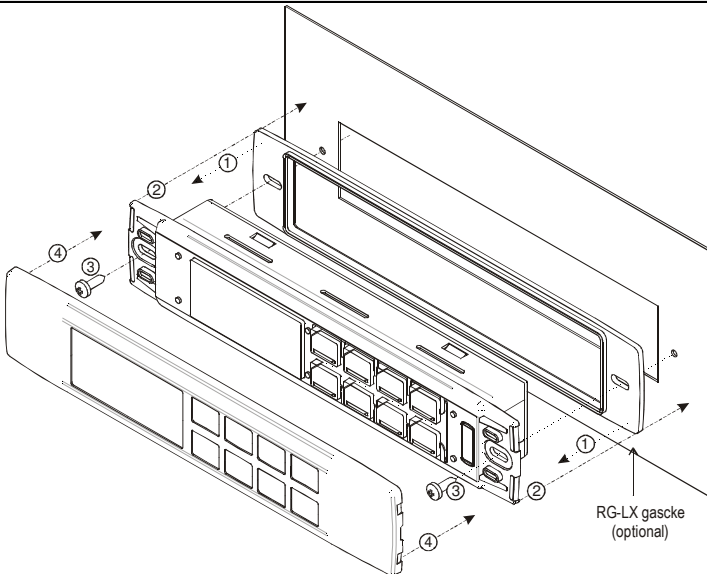

11. XB07PR - Printer (optional)

The XB570L is designed to work with the XB07PR.

The XB07PR kit is composed by:

1. Printer
2. Power adapter
3. Connecting cables

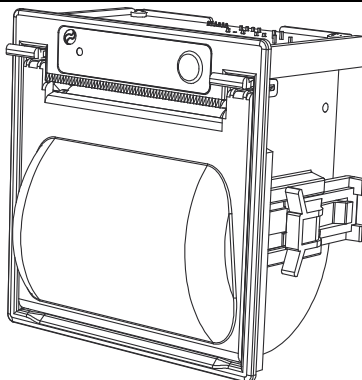

11.1 PRINTER DIMENSIONS

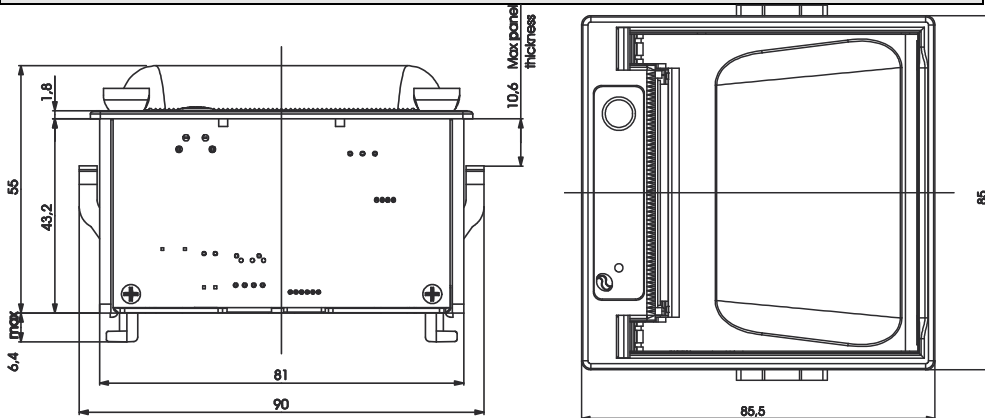

11.2 PRINTER MOUNTING

SCREW FIXING

PANEL CUT OUT

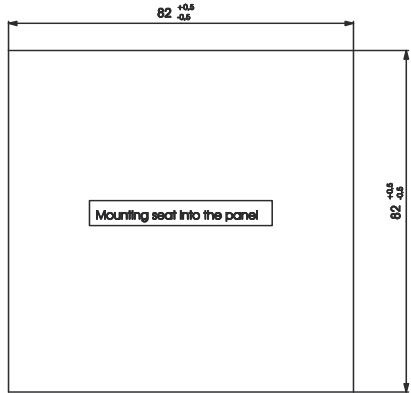
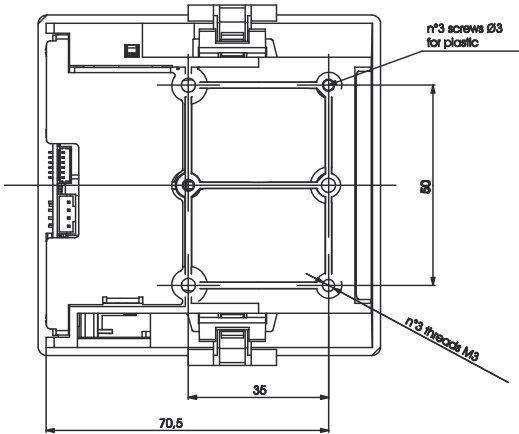

11.3 CONNECTION TO THE XB570L – XB07PR

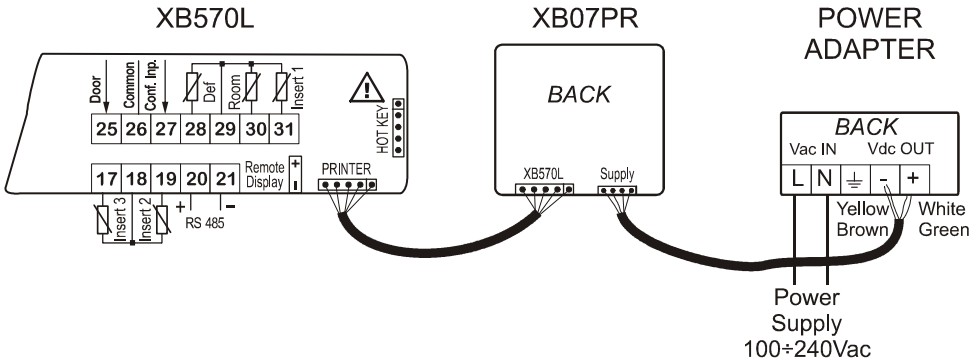

12. Electrical connections

The instruments are provided with screw terminal block to connect cables with a cross section up to 2,5 mm² for the digital and analogue inputs. Relays and power supply have a Faston connection (6,3mm). Heat-resistant cables have to be used. Before connecting cables make sure the power supply complies with the instrument's requirements. Separate the probe cables from the power supply cables, from the outputs and the power connections. Do not exceed the maximum current allowed on each relay, in case of heavier loads use a suitable external relay.

N.B. Maximum current allowed for all the loads is 20A.

12.1 PROBE CONNECTIONS

The probes shall be mounted with the bulb upwards to prevent damages due to casual liquid infiltration. It is recommended to place the thermostat probe away from air streams to correctly measure the average room temperature.

13. TTL Serial line

The TTL connector allows, by means of the external module TTL/RS485, to connect the unit to a network line **ModBUS-RTU** compatible as the **dixell** monitoring system XJ500 (Version 3.0).

The same TTL connector is used to upload and download the parameter list of the **"HOT KEY"**.

14. Use of the programming "HOT KEY "

The Wing units can UPLOAD or DOWNLOAD the parameter list from its own E2 internal memory to the **"Hot Key"** and vice-versa.

14.1 DOWNLOAD (FROM THE "HOT KEY" TO THE INSTRUMENT)

1. Turn OFF the instrument by means of the ON/OFF key, remove the TTL serial cable if present, insert the **"Hot Key"** and then turn the Wing ON.
2. Automatically the parameter list of the **"Hot Key"** is downloaded into the Wing memory, the **"DoL"** message is blinking. After 10 seconds the instrument will restart working with the new parameters.
3. Turn OFF the instrument remove the **"Hot Key"**, plug in the TTL serial cable, then turn it ON again.

At the end of the data transfer phase the instrument displays the following messages:

"end " for right programming. The instrument starts regularly with the new programming.

"err" for failed programming. In this case turn the unit off and then on if you want to restart the download again or remove the **"Hot key"** to abort the operation.

14.2 UPLOAD (FROM THE INSTRUMENT TO THE "HOT KEY")

1. Turn OFF the instrument by means of the ON/OFF key and remove the TTL serial cable if present; then turn it ON again.
2. When the Wing unit is ON, insert the **"Hot key"** and push **▲** key; the **"uPL"** message appears.
3. Push **"SET"** key to start the UPLOAD; the **"uPL"** message is blinking.
4. Turn OFF the instrument remove the **"Hot Key"**, plug in the TTL serial cable, then turn it ON again.

At the end of the data transfer phase the instrument displays the following messages:

"end " for right programming.

"err" for failed programming. In this case push **"SET"** key if you want to restart the programming again or remove the not programmed **"Hot key"**.

15. ALARM SIGNALS

Mess.	Cause	Outputs
"EE"	Data or memory failure	Alarm output ON; Other outputs unchanged
"rPF"	Thermostat Probe failure	Alarm output ON; Compressor output according to parameters "CON" and "COF"
"EPF"	Evaporator Probe failure	Alarm output ON; Defrost termination is timed; No temperature control on fans.
"i1P"; "i2P"; "i3P"	Insert probe 1, 2, 3, failure	Alarm output ON; Other outputs unchanged; The cycle is made by time
"rtC"	Real Time Clock data lost	Alarm output ON; Other outputs unchanged;
"rtF"	Real Time Clock failure	Alarm output ON; Other outputs unchanged; The date and the duration of the cycle are not available.
"HA"	Maximum temperature alarm	Alarm output ON; Other outputs unchanged.

Mess.	Cause	Outputs
“LA”	Minimum temperature alarm	Alarm output ON; Other outputs unchanged.
“FF”	Fast freezing interrupted by short power failure	Alarm output ON; The freezing cycle restart from the same point at which was interrupted.
“PFA”	Fast freezing interrupted by long power failure	Alarm output ON; The freezing cycle restart from the current phase.
“OCF”	Max duration of the cycle is expired	Alarm output ON; Other outputs unchanged. In any case the cycle ends when the final temperature is reached
“EA”	External alarm	Alarm output ON; Other outputs unchanged.
“CA”	Serious external alarm	Alarm output ON; Other outputs OFF.
“dA”	Door open alarm	Alarm output ON; Other outputs unchanged.

16. Technical data

Housing: self extinguishing ABS.

Case: frontal 185x38 mm; depth 70mm;

Mounting: panel mounting in a 150x31mm panel cut-out

Frontal protection: IP65

Connections: Screw terminal block ≤ 2,5mm² wiring.

Power supply: 230Vac, ±10%

Power absorption: 5VA max.

Display: dual display

Inputs: 5 PTC or NTC probes

Relay outputs:

compressor: relay SPST 20(8)A or 8(3) A, 250Vac

defrost: relay 8(3)A, 250Vac

fans: relay SPST 8(3)A, 250Vac

Light : relay SPST 16(6)A, 250Vac

Aux1 : relay SPST 8(3)A, 250Vac

Aux2 : relay SPST 16(6)A, 250Vac

Serial output: RS232 serial output for XB07PR printer connection

Serial output: TTL serial output for monitoring system (MODBUS-RTU) protocol

Data storing: on the non-volatile memory (EEPROM).

Operating temperature: 0÷60 °C.

Storage temperature: -30÷85 °C.

Relative humidity: 20÷85% (no condensing)

Measuring range: -55÷50 °C

Resolution: 0,1 °C or 1 °F (selectable).

Accuracy of the controller at 25 °C: ±0,3 °C ±1 digit

17. Standard Value of the cycles.

Cy1: for fast chilling and conservation of foods at positive temperature		
CyS = tEP	iS2 = 5 °C (41 °F)	Pd3 = OFF
dbC = no	rS2 = -2 °C (28 °F)	dbH = yes
iS1 = 20 °C (68 °F)	Pd2 = 2.0 h	HdS = 3 °C (37 °F)
rS1 = -10 °C (14 °F)	iS3 = 3 °C (37 °F)	
Pd1 = 2.0 h	rS3 = -2 °C (28 °F)	

Cy2: for chilling and fast freezing of foods with holding		
CyS = tEP	iS2 = 5 °C (41 °F)	Pd3 = 2.0 h

dbC = no	rS2 = -2°C (28°F)	dbH = YES
iS1 = 10°C (50°F)	Pd2 = 2.0 h	HdS = -18°C (0°F)
rS1 = -10°C (14°F)	iS3 =-18°C (0°F)	
Pd1 = 2.0 h	rS3 =-30°C (-22°F)	

Cy3: direct fast freezing with holding		
CyS = tEP	iS2 =-18°C (0°F)	Pd3 = OFF
dbC = no	rS2 =-30°C(-22°F)	dbH = yes
iS1 = -18°C (0°F)	Pd2 =OFF	HdS = -18°C (0°F)
rS1 =-30°C (-22°F)	iS3 =-18°C (0°F)	
Pd1 = 4.0	rS3 =-30°C (-22°F)	

Cy4: direct fast freezing without holding		
CyS = tEP	iS2 =-18°C (0°F)	Pd3 = OFF
dbC = no	rS2 =-30°C (-22°F)	dbH = no
iS1 =-18°C (0°F)	Pd2 =OFF	HdS = OFF
rS1 =-30°C (-22°F)	iS3 =-18°C (0°F)	
Pd1 = 4.0	rS3 =-30°C (-22°F)	



18. Standard Values of the parameters.

Lab	Description	Values	Level
Set	Set point	3.0	- - -
Hy	differential	2.0	Pr1
AC	Anti-short cycle delay	1	Pr2
PAU	Time of stand by	0	Pr2
PFt	Maximum acceptable duration of power failure	15	Pr2
Con	Compressor ON time with faulty probe	15	Pr2
COF	Compressor OFF time with faulty probe	10	Pr2
rPO	Thermostat probe calibration	0.0	Pr2
EPP	Evaporator probe presence	YES	Pr2
EPO	Evaporator probe calibration	0.0	Pr2
i1P	Insert probe 1 presence	YES	Pr2
i1o	Insert probe 1 calibration	0.0	Pr2
i2P	Insert probe 2 presence	n	Pr2
i2o	Insert probe 2 calibration	0	Pr2
i3P	Insert probe 3 presence	n	Pr2
i3o	Insert probe 3 calibration	0	Pr2
rEM	Probe selection to stop chilling cycle	iPt	Pr2
CF	Temperature measurement unit	°C	Pr2
rES	Resolution (for °C):	dE	Pr2
Lod	Local display	rP	Pr2
rEd	Remote display	rP	Pr2
d1P	Door switch polarity	cL	Pr2
Odc	Open door control	F-C	Pr2
dOA	Open door alarm delay	5	Pr2
dLc	Stop count down of running cycle	y	Pr2
rrd	Regulation restart after door open alarm	Y	Pr2
d2F	Second digital input function	EAL	Pr2
d2P	Second digital input polarity	cL	Pr2
did	Time delay for digital input alarm	5	Pr2
oA1	First configurable relay function	tMr	Pr2
oA2	Second configurable relay function	ALL	Pr2
oA3	Third configurable relay function	Lig	Pr2
2CH	Compressor setting during the holding	C1	Pr2
OAt	Second compressor switching on delay	3	Pr2
OAS	Set point for second compressor	0	Pr2
OAH	Differential for second compressor	2,0	Pr2
OAi	Probe selection for second compressor	rP	Pr2
OSt	Auxiliary output timer	0	Pr2
OSS	Set point for auxiliary output	0	Pr2
OSH	Differential for auxiliary output	2.0	Pr2
OSi	Probe selection for auxiliary output	rP	Pr2

Lab	Description	Values	Level
tdF	Defrost type	rE	Pr2
IdF	Interval between defrost cycles	6.0	Pr2
dtE	Defrost termination temperature	8	Pr2
MdF	Maximum length for defrost	20	Pr2
dFd	Temperature displayed during defrost	rt	Pr2
Fdt	Drip time	0	Pr2
dAd	Defrost display time out	20	Pr2
FnC	Fan operating mode	c_n	Pr2
FSt	Fan stop temperature	30	Pr2
AFH	Differential for the stop temperature and for the alarm	2.0	Pr2
Fnd	Fan delay after defrost	2	Pr2
ALU	MAXIMUM temperature alarm	30	Pr2
ALL	Minimum temperature alarm	30	Pr2
ALd	Temperature alarm delay	15	Pr2
EdA	Alarm delay after defrost	30	Pr2
tbA	Silencing alarm relay	YES	Pr2
tCy	Duration of last cycle	- - -	Pr1
tP1	Duration of first phase of the last cycle	- - -	Pr1
tP2	Duration of second phase of the last cycle	- - -	Pr1
tP3	Duration of third phase of the last cycle	- - -	Pr1
Adr	Address for RS485:	1	Pr2
bUt	Buzzer activation at the end of the cycle	30	Pr2
tPb	Type of probe	ntc	Pr2
rEL	Release code (readable only)	2.0	Pr2
Ptb	Parameter code (readable only)		Pr2

Dixell S.p.A.

Z.I. Via dell'Industria, 27

32010 Pieve d'Alpago (BL) ITALY

tel. +39 - 0437 - 98 33 - fax +39 - 0437 - 989 313

E-mail: dixell@dixell.com - <http://www.dixell.com>